

SELECTION CRITERIA

- Fresh water use
- Direct acting
- High capacity
- O-Ring seals
- Low maintenance
- Union connections
- 3-Way diverting configuration
- 3/4", 1", 1-1/4" & 1-1/2" sizes
- 200 PSI water pressure standard
- Higher water pressures available

CONSTRUCTION DETAILS

- Brass & stainless steel internals
- Buna-N o-ring seals
- Cast iron body

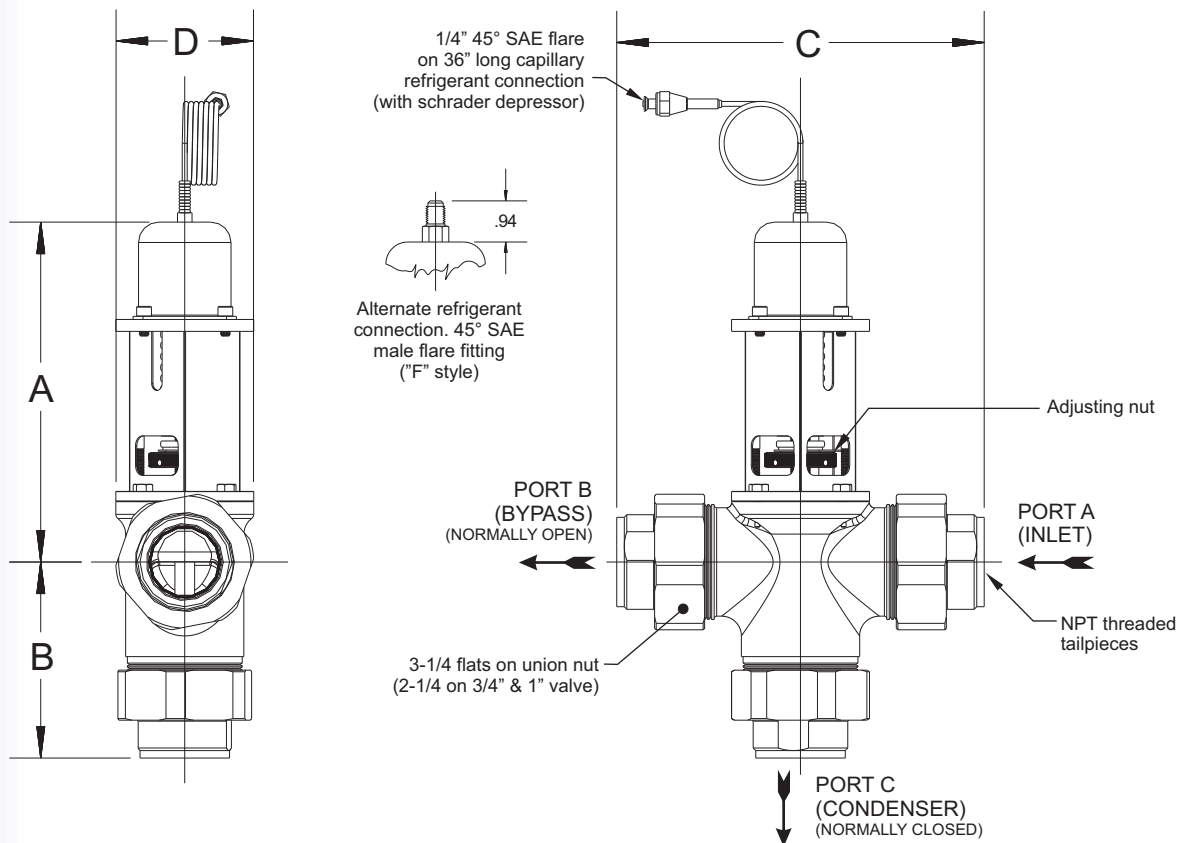

VALVE SIZING CHART

VALVE PART NUMBER	PIPE SIZE	C _v MIN PORT C PORT B	DIMENSIONS				APPROX. WEIGHT
			A ± .12	B ± .06	C ± .12	D ± .06	
93P_-75_-	3/4"	$\frac{11}{11}$	8.65	3.87	7.93	3.50	13#
93P_-100_-	1"	$\frac{11}{11}$	8.65	3.87	7.93	3.50	13#
93P_-125_-	1-1/4"	$\frac{14.5}{11}$	8.65	5.00	9.38	3.50	17#
93P_-150_-	1-1/2"	$\frac{17}{14.5}$	8.65	5.00	9.38	3.50	19#



All dimensions are in inches

ORDERING INFORMATION

- Use the valve sizing chart on the preceding page, tables, and charts below to determine the complete part number.

BASIC PART NO.: 93P - -

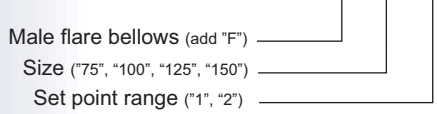

Example: • **93P-125-2**

- Standard capillary w/flange nut
- "125" = 1-1/4" pipe size
- "2" = 150-220 set point range

FLOW DATA

PRESSURE RANGE ADJUSTMENT

- The refrigerant pressure range at which Port C begins to open can be adjusted per Table I.

TABLE I	
SET POINT RANGE	ADJUSTMENT
1	70-150 PSIG
2	150-220 PSIG

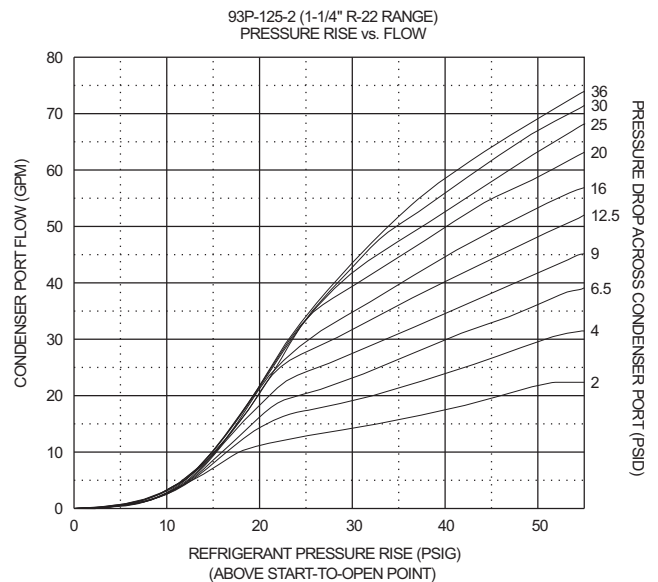
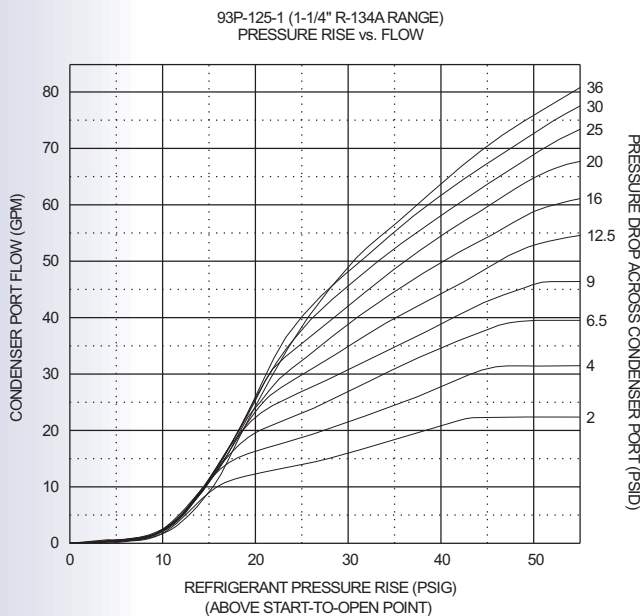
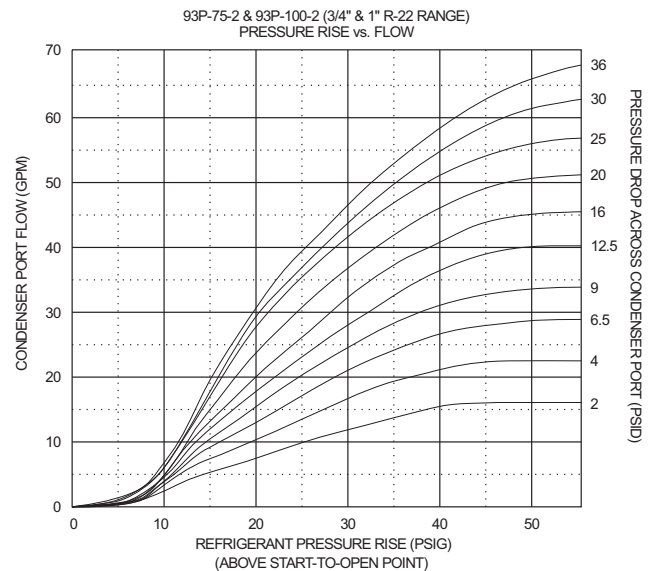
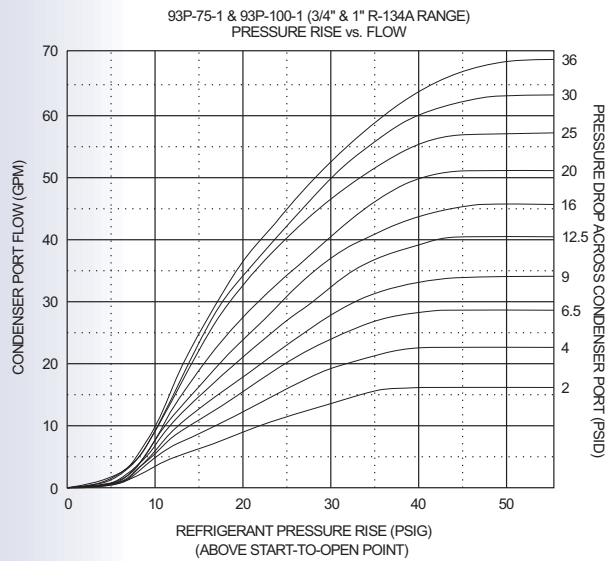

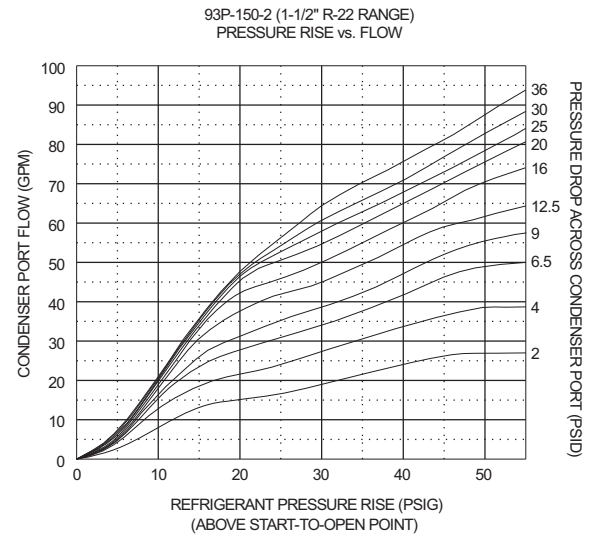
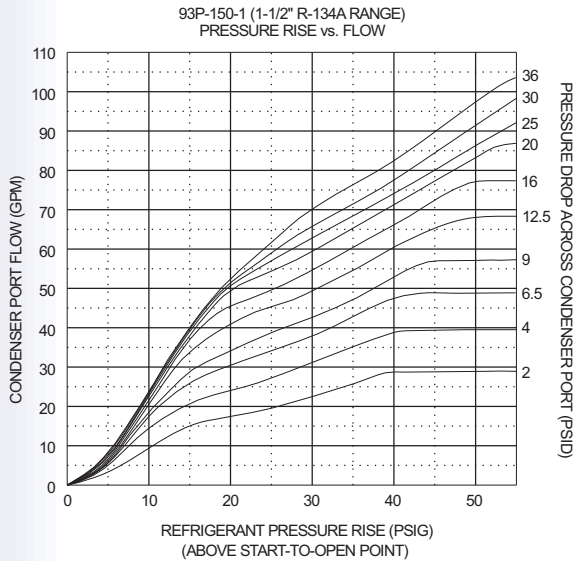

3-WAY HEAD PRESSURE REGULATOR TYPICAL APPLICATION

- Typically used to modulate the cooling water through a condenser in response to a pressure signal from the condenser. Refrigerant head pressure is maintained over a wide range of operating conditions for a maximum system operating efficiency.

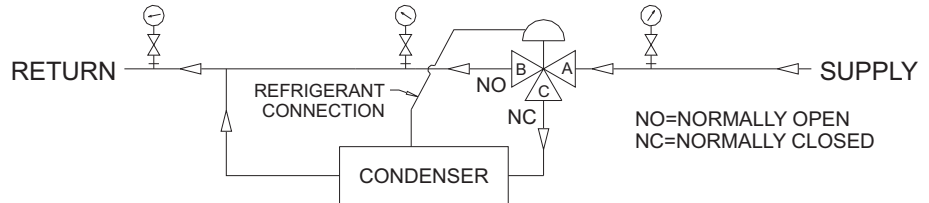

INSTALLATION INSTRUCTIONS

- Valves can be mounted in any position without affecting performance. However, for ease of adjustment consider the accessibility of the adjusting nut.
- Connect the incoming water line to the valve inlet (Port A). Direction of water flow is indicated by the arrow cast on the side of the valve body. Port C (normally closed) is typically piped to the condenser inlet. Port B should be piped to bypass the condenser.
- Connect refrigerant connection capillary to refrigerant pressure connection on the condenser.

ADJUSTMENT

- The refrigerant pressure at which Port C begins to open can be adjusted as shown in Table I. Port B closes proportionally as Port C opens. To increase the refrigerant head pressure setting, insert a 1/8" pin or hex key into the adjustment nut and turn counter-clockwise. To lower refrigerant head pressure setting, turn adjustment nut clockwise.

GENERAL DESCRIPTION

- The 93P series valves are direct acting, modulating water regulating valves. All water pressure boundaries are o-ring sealed for leak-proof, set & forget reliability. Union ends with special o-ring seals make for quick and easy installation.