

### SELECTION CRITERIA

- Marine water use
- Direct acting
- Actuation by temperature
- Open on temperature increase
- Optional open on temperature decrease
- Union end connections
- 2-way configuration
- 3/8" thru 1-1/2" sizes
- 150 PSI water pressure rating
- 225 PSI proof pressure

### CONSTRUCTION DETAILS

- Monel internals
- Buna-N diaphragms & seals
- Bronze body

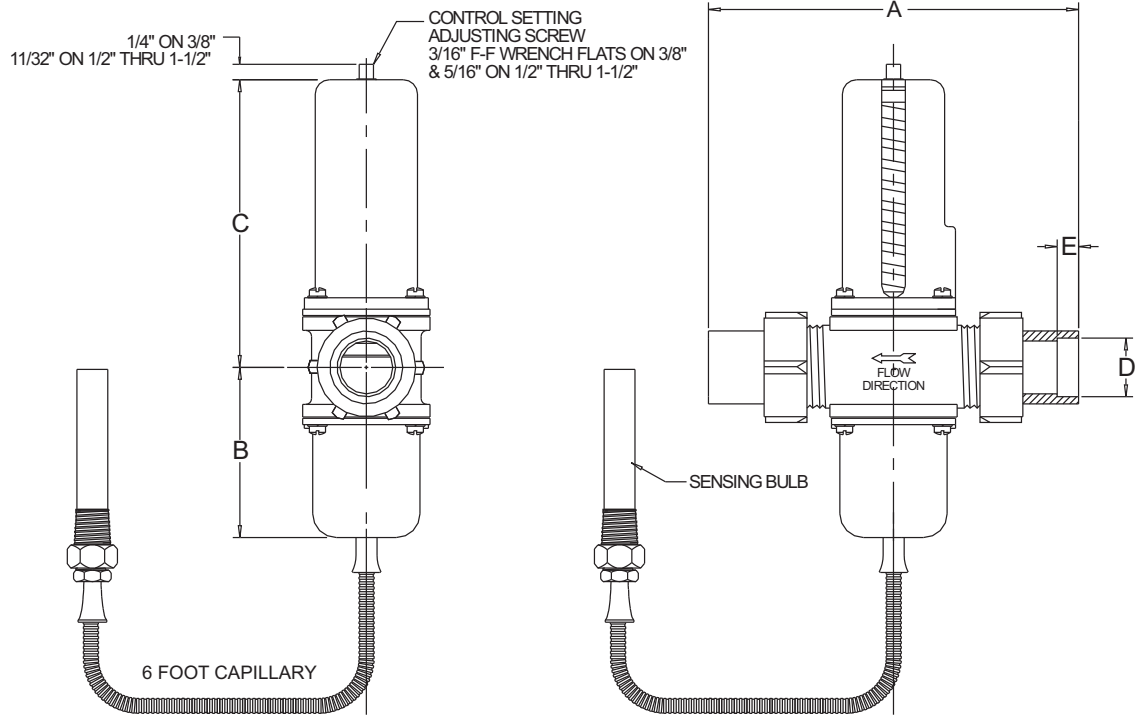

### VALVE SIZING CHART

VALVE PART NUMBER	PIPE SIZE	C <sub>v</sub>	DIMENSIONS			TYPE I		TYPE II		MIL-F-1183	
			A	B	C	D	E	D	E	D	E
DA867T-37-UEM	3/8"	2.3	4-1/2"	2-5/32"	3-7/32"	0.505"	3/8"	0.630"	1/2"	.675"	.313"
DA867T-50-UEM	1/2"	3	5"	2-5/8"	3-21/32"	0.630"	1/2"	0.880"	5/8"	.840"	.375"
DA867T-75-UEM	3/4"	5	5-9/16"	2-3/4"	3-13/16"	0.880"	3/4"	1.130"	7/8"	1.050"	.406"
DA867T-100-UEM	1"	7	6-63/64"	3-21/32"	6-3/16"	1.130"	29/32"	1.380"	29/32"	1.315"	.438"
DA867T-125-UEM	1-1/4"	13	7-13/32"	3-13/16"	6-5/16"	N/A	N/A	N/A	N/A	1.660"	.500"
DA867T-150-UEM	1-1/2"	14	8-9/32"	3-13/16"	6-5/16"	N/A	N/A	1.630"	1/2"	1.900"	.625"

### ORDERING INFORMATION

- Use the valve sizing chart on the preceding page tables and charts on page 4 to determine the complete part number.

**BASIC PART NO.: DA867T - - - 50M-XXX-X**

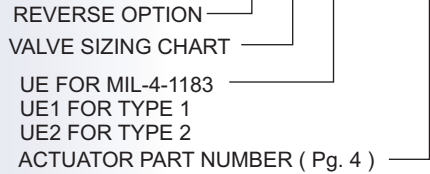

- The optional reverse acting configuration (closes on temperature increase) is designated by an "R" after the T.

Example: DA867TR-150-UEM2-50M-XXX-X

### TEMPERATURE RANGES

Range Designator	Crack Open Temperature Adjustment Range	Change to Full Open Across the Range*
L low	5 to 105 F (-15 to 40 C)	35 to 12 F (19 to 7 C)
X cross ambient	60 to 140 F (15 to 60 C)	25 to 12 F (14 to 7 C)
S standard	90 to 140 F (30 to 60 C)	20 to 12 F (11 to 7 C)
H high	100 to 170 F (40 to 80 C)	25 to 12 F (14 to 7 C)
V very high	160 to 230 F (70 to 110 C)	40 to 21 F (22 to 12 C)

\* The temperature change necessary to bring the valve from crack to full open decreases exponentially from the low end of the Crack Open Temperature to the high end of the Crack Open Temperature in each range. Example: a valve with a S (standard) range actuator set to open at 95°F will require an approximate rise in temperature of 20°F to go full open. The same valve set to open at 135°F will require an approximate rise in temperature of 12°F to go full open.

### FLOW DATA

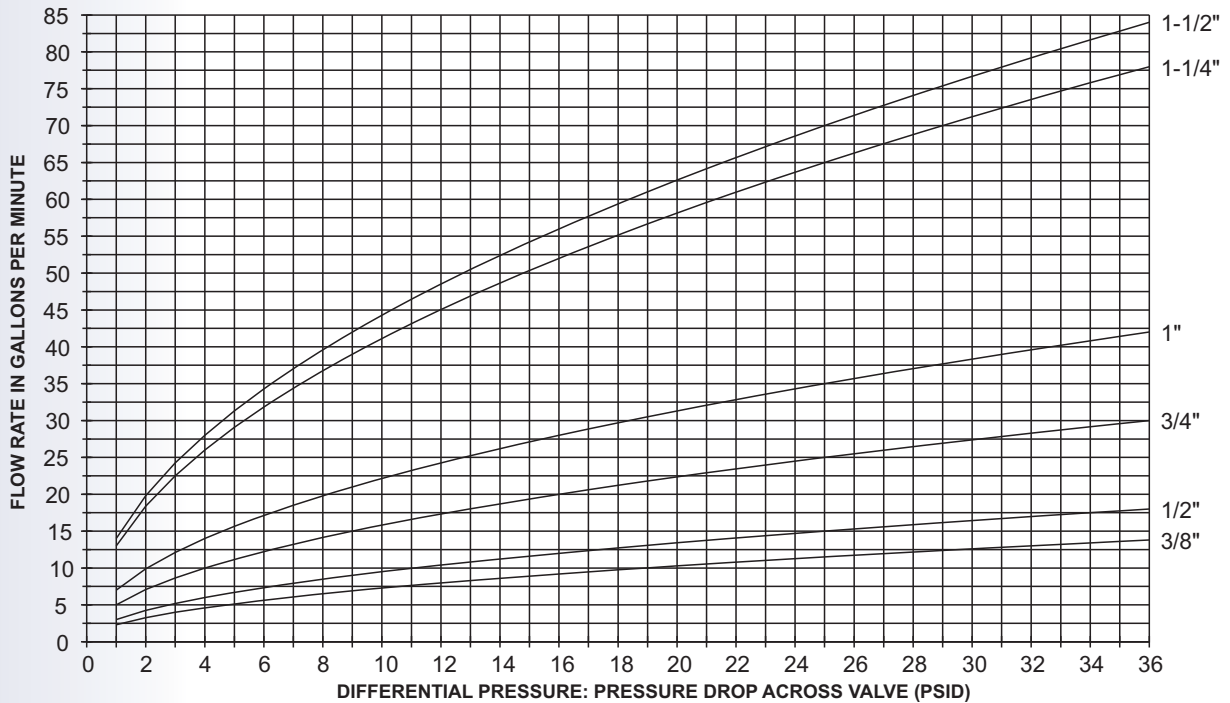

### 2-WAY TEMPERATURE REGULATOR TYPICAL APPLICATION

- Thermostatic actuated valves are typically used to modulate the water flow in response to a temperature signal and are used in a wide variety of industrial and commercial process control applications where water is used as a heat transfer medium. For example, this type of valve is used to maintain precise control of the temperature of Hydraulic fluid in plastic injection molding Equipment.

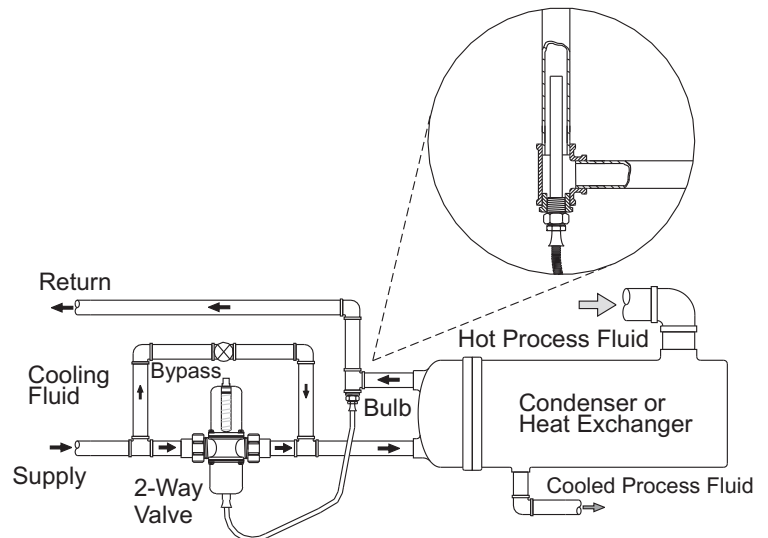

The Bypass valve allows an adjustable, continuous low flow of water (usually 10% of maximum flow) through the heat exchanger to transport heat to the sensing bulb. Valves with internal bypass are available.

### INSTALLATION INSTRUCTIONS

- Valves can be mounted in any position without affecting performance. However, for ease of adjustment consider the accessibility of the adjusting screw.
- Connect the incoming water line to the valve inlet. Direction of water flow (see drawing) is indicated by the arrow cast on the side of the valve body.
- Insert / Install sensing bulb in desired location.

### GENERAL DESCRIPTION

- The DA series valves are direct acting, modulating water regulating valves utilizing a diaphragm construction to give a smooth, well balanced action. The pressure-balanced design and low frictional coefficient of the diaphragm assure fast response to changes in temperature and protection against both gradual and sudden water pressure changes. All sliding parts and adjustment springs are isolated from the water flow by the leak proof diaphragms.

### ADJUSTMENT

- To adjust temperature setting, use wrench and turn adjusting screw on top of the spring housing. Turn counter clockwise to raise the temperature and clockwise to lower.

### MANUAL OVERRIDE

- All valves may be manually flushed by inserting a screwdriver in openings at opposite sides of the spring housing and lifting the lower spring plate to open the valve. The valve adjustment is not affected by manual flushing.



### TO DETERMINE ACTUATOR PART NUMBER

1. Select the desired Bulb style for the appropriate valve series.
2. Select the Applicable Valve size.
3. Select the Temperature Range to reference the part number.

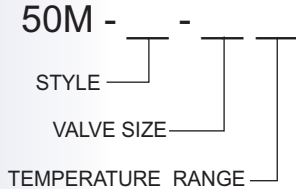

Example: For a 1" 2-Way application to control at 110°F, you could select our DA867 Series valve and specify a 50M-203-1S thermostatic actuator (see Model 203 on right).

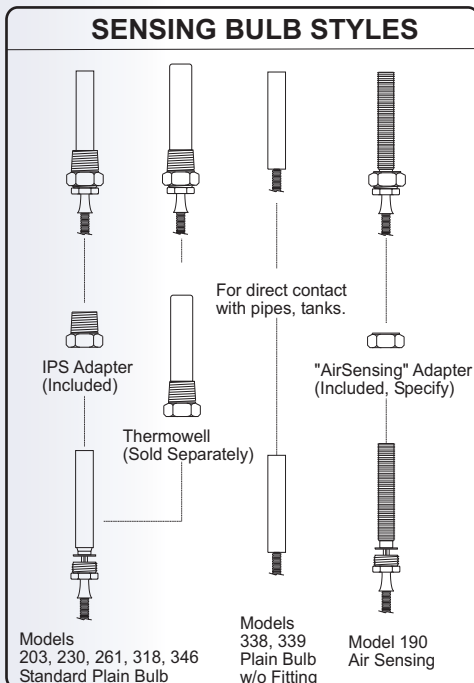
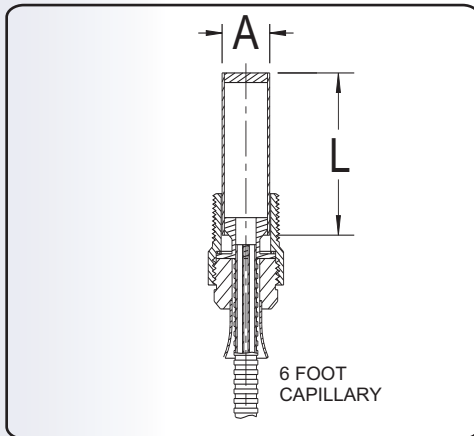

MODEL 190 • FINNED TUBE AIR SENSING TYPE • "A"=3/4"			
VALVE SIZE	TEMPERATURE RANGE (°F)	L (in)	PART NUMBER
3/8	5-105 or 60-140	6.00	50M-190-37L or 37X
	90-140	2.00	50M-190-37S
	100-170 or 160-230	2.00	50M-190-37H or 37V
1/2, 3/4	5-105 or 60-140	9.00	50M-190-50L or 50X
	90-140	3.00	50M-190-50S
	100-170 or 160-230	3.00	50M-190-50H or 50V
1, 1-1/4, 1-1/2	5-105 or 60-140	24.00	50M-190-1L or 1X
	90-140	7.00	50M-190-1S
	100-170 or 160-230	7.00	50M-190-1H or 1V

MODEL 203 • 3/4" NPT INSERTION TYPE • "A"=3/4"			
VALVE SIZE	TEMPERATURE RANGE (°F)	L (in)	PART NUMBER
3/8	5-105 or 60-140	4.50	50M-203-37L or 37X
	90-140	2.25	50M-203-37S
	100-170 or 160-230	2.25	50M-203-37H or 37V
1/2, 3/4	5-105 or 60-140	6.00	50M-203-50L or 50X
	90-140	2.25	50M-203-50S
	100-170 or 160-230	2.25	50M-203-50H or 50V
1, 1-1/4, 1-1/2	5-105 or 60-140	15.00	50M-203-1L or 1X
	90-140	4.50	50M-203-1S
	100-170 or 160-230	4.50	50M-203-1H or 1V

MODEL 230 • 1/2" NPT INSERTION TYPE • "A"=9/16"			
VALVE SIZE	TEMPERATURE RANGE (°F)	L (in)	PART NUMBER
3/8	5-105 or 60-140	8.00	50M-230-37L or 37X
	90-140	2.00	50M-230-37S
	100-170 or 160-230	2.00	50M-230-37H or 37V
1/2, 3/4	5-105 or 60-140	11.00	50M-230-50L or 50X
	90-140	4.00	50M-230-50S
	100-170 or 160-230	4.00	50M-230-50H or 50V
1, 1-1/4, 1-1/2	5-105 or 60-140	30.00	50M-230-1L or 1X
	90-140	8.00	50M-230-1S
	100-170 or 160-230	8.00	50M-230-1H or 1V

MODEL 338 • PLAIN TUBE STRAP-ON TYPE • "A"=3/4"			
VALVE SIZE	TEMPERATURE RANGE (°F)	L (in)	PART NUMBER
3/8	5-105 or 60-140	4.50	50M-338-37L or 37X
	90-140	2.25	50M-338-37S
	100-170 or 160-230	2.25	50M-338-37H or 37V
1/2, 3/4	5-105 or 60-140	6.00	50M-338-50L or 50X
	90-140	2.25	50M-338-50S
	100-170 or 160-230	2.25	50M-338-50H or 50V
1, 1-1/4, 1-1/2	5-105 or 60-140	15.00	50M-338-1L or 1X
	90-140	4.50	50M-338-1S
	100-170 or 160-230	4.50	50M-338-1H or 1V

MODEL 346 • 1" NPT INSERTION TYPE • "A"=1"			
VALVE SIZE	TEMPERATURE RANGE (°F)	L (in)	PART NUMBER
1, 1-1/4, 1-1/2	5-105 or 60-140	10.00	50M-346-1L or 1X